

FLEXIBLE COUPLING DETAILS

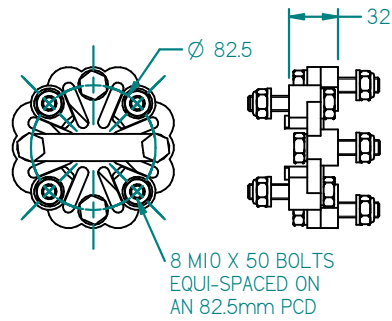

FLEXIBLE MOUNT DETAILS

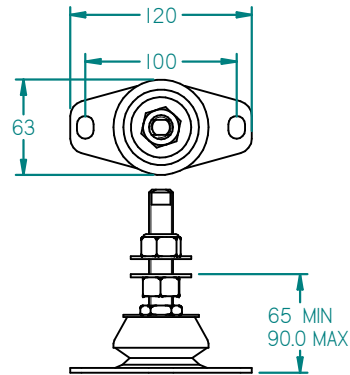

GEARBOX FLANGE

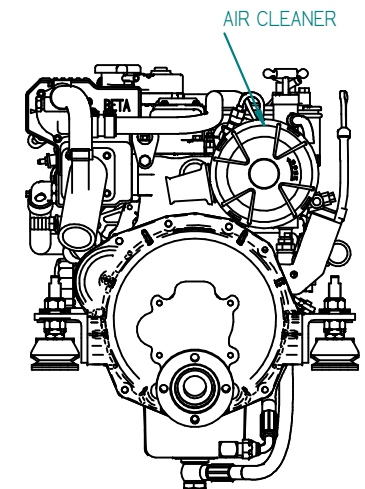
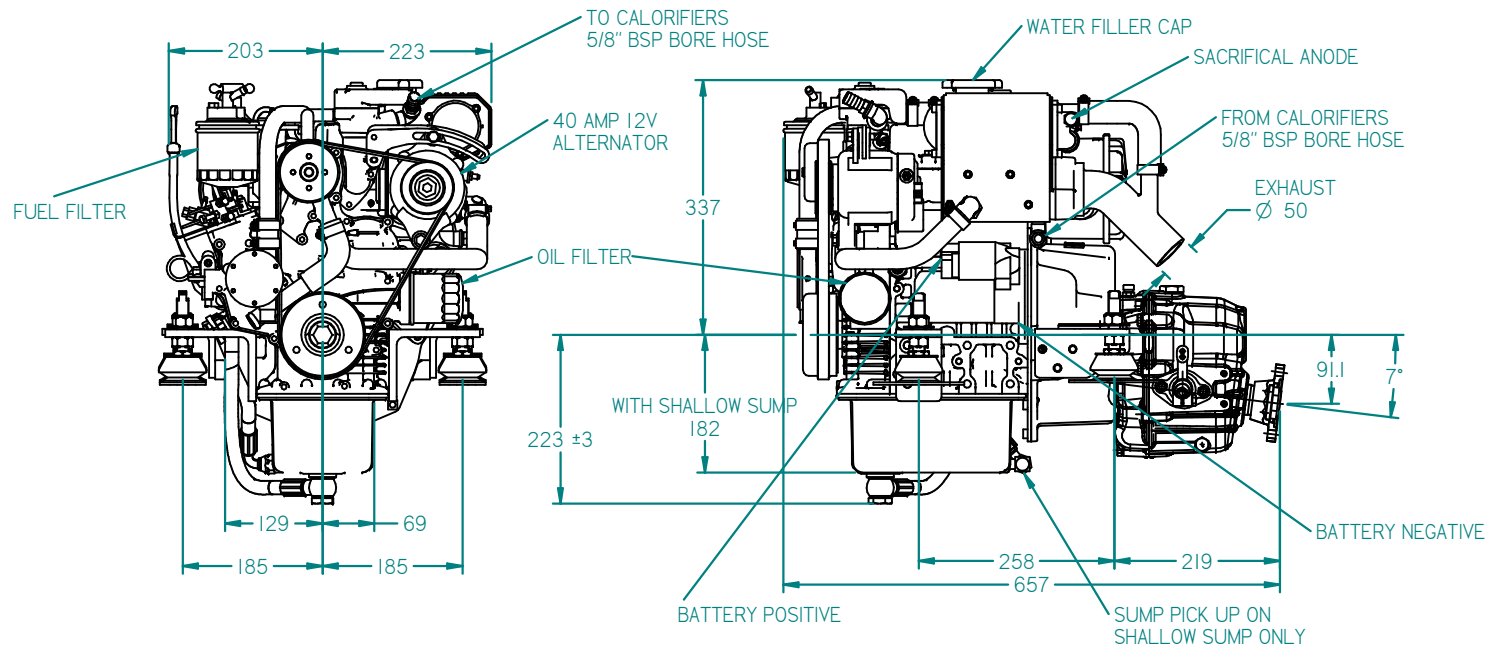
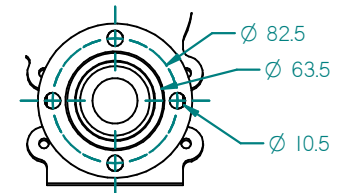

REV	DESCRIPTION	DATE	APP'D	DRAWN	NOTES	TITLE:
01						BETA 16 HEAT EXCHANGE TMC60A GEARBOX
DIMENSIONS IN MM (INCH) DO NOT SCALE						PART FILE NAME: BETA 16 HE TMC60A 100-09181.asm
						DRAWN BY: TW CHECKED BY: LT
BETA MARINE LTD, DAVY WAY, WATERWELLS, QUEDGELEY, GLOUCESTER. GL2 2AD, UK TEL: (01452) 723492 FAX: (01452) 729916						SIZE A4 DWG NO: 100-09181 SCALE NTS PAGE 1 of 1 DATE 19/03/2014
						REV 00